

LSA 52.3

Low Voltage Alternator - 4 pole

1860 to 2750 kVA - 50 Hz / 2230 to 3400 kVA - 60 Hz
Electrical and mechanical data

LEROY-SOMER[™]

Nidec
All for dreams

Specially adapted to applications

The LSA 52.3 alternator is designed to be suitable for typical generator applications, such as: backup, marine applications, rental, telecommunications, etc.

Compliant with international standards

The LSA 52.3 alternator conforms to the main international standards and regulations: IEC 60034, NEMA MG 1.32-33, ISO 8528-3, CSA C22.2 n°100-14, UL 1446 (UL 1004 on request), marine regulations, etc.

It can be integrated into a EC marked generator.

The LSA 52.3 is designed, manufactured and marketed in an ISO 9001 and ISO 14001 environment.

Top of the range electrical performance

- Class H insulation
- Standard 6-wire winding, 2/3 pitch, type no. 6S
- Voltage range 50 Hz: 380V - 400V - 415V - 440 V
- Voltage range 60 Hz: 380V - 416V - 440V - 480V
- High efficiency and motor starting capacity
- Other voltages are possible with optional adapted windings
 - 50 Hz : 440 V (no. 7S), 500 V (no. 9S), 600 V (no. 22S or 23S), 690 V (no. 10S or 52S)
 - 60 Hz : 380 V and 416 V (no. 8S), 600 V (no. 9S)
- Complies with EN 61000-6-3, EN 61000-6-2, EN 55011, group 1 class B for European zone (EC marking)

Advanced control system

The standard excitation system for the LSA 52.3 is an AREP + PMI auxiliary winding with permanent magnets.

The system is operated by a fully configurable D550 digital automatic voltage regulator.

The system also uses three-phase detection for precise and reactive regulation.

Options:

- Equipment for mains paralleling
- PMG excitation system
- Remote voltage potentiometer

Protection system suited to the environment

- The LSA 52.3 is IP 23
- Standard winding protection for clean environments with relative humidity $\leq 95\%$, including indoor marine environments.
 - Options : - Filters on air inlet : derating 5%
 - Filters on air inlet and air outlet (IP 44) : derating 8%
 - Winding protections for harsh environments and relative humidity greater than 95%
 - Space heaters
 - Protection or metering CTs
 - Thermal protection for stator windings &/or bearings (PT100)

Reinforced mechanical structure using finite element modelling

- Compact and rigid assembly to better withstand generator vibrations
- Steel frame
- Cast iron flanges and shields
- Twin-bearing and single-bearing versions designed to be suitable for engines on the market
- Half-key balancing
- Regreasable bearings
- Clockwise rotation in standard

Accessible terminal box proportioned for optional equipment

- Easy access to the voltage regulator and to the connections
- Possible inclusion of accessories for paralleling, protection and measurement

General characteristics

| | | | |
|------------------|---|--|-------------------|
| Insulation class | H | Excitation system | AREP + PMI |
| Winding pitch | 2/3 (n° 6S) | AVR type | D550 |
| Number of wires | 6 | Voltage regulation (*) | ± 0.5% |
| Protection | IP 23 | Short-circuit current | 300% (3 IN) : 10s |
| Altitude | ≤ 1000 m | Total Harmonic Distortion THD (**) in no-load: | < 4% |
| Overspeed | 2250 min ⁻¹ | Waveform: NEMA = TIF (**) | < 50 |
| Air flow | 2.5 m ³ /s (50 Hz) - 2.8 m ³ /s (60 Hz) | Waveform: I.E.C. = THF (**) | < 2% |

(*) steady state (**) between phases

Ratings 50 Hz - 1500 R.P.M.

| kVA / kW - P.F. = 0.8 | | | | | | | | | | | | | | | | | |
|-----------------------|-----|----------------------|-------------|------|------|----------------------|-------------|------|------|---------------|-------------|------|------|---------------|-------------|------|------|
| Duty/T°C | | Continuous duty/40°C | | | | Continuous duty/40°C | | | | Stand-by/40°C | | | | Stand-by/27°C | | | |
| Class/T°K | | H/125°K | | | | F/105°K | | | | H/150°K | | | | H/163°K | | | |
| Phase | | 3 ph. | | | | 3 ph. | | | | 3 ph. | | | | 3 ph. | | | |
| Y | | 380V | 400V | 415V | 440V | 380V | 400V | 415V | 440V | 380V | 400V | 415V | 440V | 380V | 400V | 415V | 440V |
| LSA 52.3 S5 | kVA | 1860 | 1860 | 1860 | 1691 | 1696 | 1696 | 1696 | 1542 | 1953 | 1953 | 1953 | 1775 | 2046 | 2046 | 2046 | 1860 |
| | kW | 1488 | 1488 | 1488 | 1353 | 1357 | 1357 | 1357 | 1234 | 1562 | 1562 | 1562 | 1420 | 1637 | 1637 | 1637 | 1488 |
| LSA 52.3 S6 | kVA | 2000 | 2000 | 2000 | 1818 | 1824 | 1824 | 1824 | 1658 | 2100 | 2100 | 2100 | 1909 | 2200 | 2200 | 2200 | 2000 |
| | kW | 1600 | 1600 | 1600 | 1454 | 1459 | 1459 | 1459 | 1326 | 1680 | 1680 | 1680 | 1527 | 1760 | 1760 | 1760 | 1600 |
| LSA 52.3 S7 | kVA | 2200 | 2200 | 2200 | 2000 | 2006 | 2006 | 2006 | 1824 | 2310 | 2310 | 2310 | 2100 | 2420 | 2420 | 2420 | 2200 |
| | kW | 1760 | 1760 | 1760 | 1600 | 1605 | 1605 | 1605 | 1459 | 1848 | 1848 | 1848 | 1680 | 1936 | 1936 | 1936 | 1760 |
| LSA 52.3 L9 | kVA | 2360 | 2360 | 2360 | 2145 | 2152 | 2152 | 2152 | 1956 | 2478 | 2478 | 2478 | 2253 | 2596 | 2596 | 2596 | 2360 |
| | kW | 1888 | 1888 | 1888 | 1716 | 1722 | 1722 | 1722 | 1565 | 1982 | 1982 | 1982 | 1802 | 2077 | 2077 | 2077 | 1888 |
| LSA 52.3 L12 | kVA | 2560 | 2560 | 2560 | 2327 | 2335 | 2335 | 2335 | 2123 | 2688 | 2688 | 2688 | 2444 | 2816 | 2816 | 2816 | 2560 |
| | kW | 2048 | 2048 | 2048 | 1862 | 1868 | 1868 | 1868 | 1698 | 2150 | 2150 | 2150 | 1955 | 2253 | 2253 | 2253 | 2048 |
| LSA 52.3 UL16 | kVA | 2750 | 2750 | 2750 | 2500 | 2508 | 2508 | 2508 | 2280 | 2888 | 2888 | 2888 | 2625 | 3025 | 3025 | 3025 | 2750 |
| | kW | 2200 | 2200 | 2200 | 2000 | 2006 | 2006 | 2006 | 1824 | 2310 | 2310 | 2310 | 2100 | 2420 | 2420 | 2420 | 2200 |

Ratings 60 Hz - 1800 R.P.M.

| kVA / kW - P.F. = 0.8 | | | | | | | | | | | | | | | | | |
|-----------------------|-----|----------------------|------|------|-------------|----------------------|------|------|-------------|---------------|------|------|-------------|---------------|------|------|-------------|
| Duty/T°C | | Continuous duty/40°C | | | | Continuous duty/40°C | | | | Stand-by/40°C | | | | Stand-by/27°C | | | |
| Class/T°K | | H/125°K | | | | F/105°K | | | | H/150°K | | | | H/163°K | | | |
| Phase | | 3 ph. | | | | 3 ph. | | | | 3 ph. | | | | 3 ph. | | | |
| Y | | 380V | 416V | 440V | 480V | 380V | 416V | 440V | 480V | 380V | 416V | 440V | 480V | 380V | 416V | 440V | 480V |
| LSA 52.3 S5 | kVA | 1860 | 1934 | 2046 | 2232 | 1697 | 1765 | 1866 | 2036 | 1953 | 2031 | 2149 | 2344 | 2046 | 2128 | 2250 | 2455 |
| | kW | 1488 | 1547 | 1637 | 1786 | 1358 | 1412 | 1493 | 1629 | 1562 | 1625 | 1719 | 1875 | 1637 | 1702 | 1800 | 1964 |
| LSA 52.3 S6 | kVA | 2000 | 2080 | 2200 | 2400 | 1824 | 1897 | 2007 | 2189 | 2100 | 2184 | 2310 | 2520 | 2200 | 2288 | 2420 | 2640 |
| | kW | 1600 | 1664 | 1760 | 1920 | 1459 | 1518 | 1606 | 1751 | 1680 | 1747 | 1848 | 2016 | 1760 | 1830 | 1936 | 2112 |
| LSA 52.3 S7 | kVA | 2200 | 2288 | 2420 | 2640 | 2007 | 2087 | 2207 | 2408 | 2310 | 2402 | 2541 | 2772 | 2420 | 2517 | 2662 | 2904 |
| | kW | 1760 | 1830 | 1936 | 2112 | 1606 | 1670 | 1766 | 1926 | 1848 | 1922 | 2033 | 2218 | 1936 | 2014 | 2130 | 2323 |
| LSA 52.3 L9 | kVA | 2360 | 2454 | 2596 | 2832 | 2153 | 2239 | 2368 | 2583 | 2478 | 2577 | 2726 | 2974 | 2596 | 2700 | 2855 | 3115 |
| | kW | 1888 | 1963 | 2077 | 2266 | 1722 | 1791 | 1894 | 2066 | 1982 | 2062 | 2181 | 2379 | 2077 | 2160 | 2284 | 2492 |
| LSA 52.3 L12 | kVA | 2708 | 2817 | 2979 | 3250 | 2470 | 2569 | 2717 | 2964 | 2844 | 2958 | 3129 | 3413 | 2979 | 3098 | 3277 | 3575 |
| | kW | 2166 | 2254 | 2383 | 2600 | 1976 | 2055 | 2174 | 2371 | 2275 | 2366 | 2503 | 2730 | 2383 | 2478 | 2622 | 2860 |
| LSA 52.3 UL16 | kVA | 2833 | 2947 | 3117 | 3400 | 2584 | 2688 | 2843 | 3101 | 2975 | 3094 | 3273 | 3570 | 3117 | 3241 | 3428 | 3740 |
| | kW | 2266 | 2358 | 2494 | 2720 | 2067 | 2150 | 2274 | 2481 | 2380 | 2475 | 2618 | 2856 | 2494 | 2593 | 2742 | 2992 |

Efficiencies 400V - 50 Hz (— P.F.: 1) (----- P.F.: 0.8)

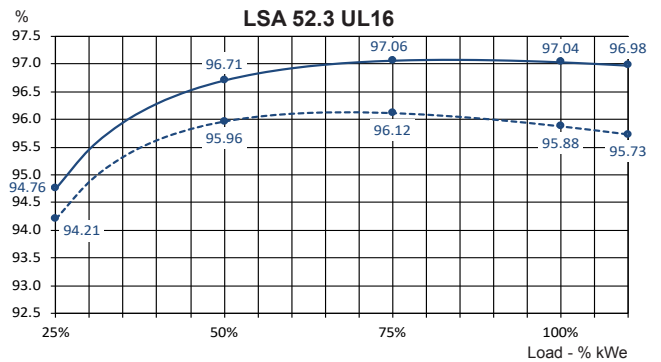
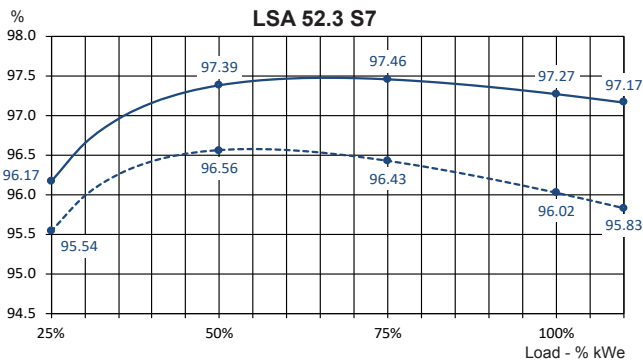
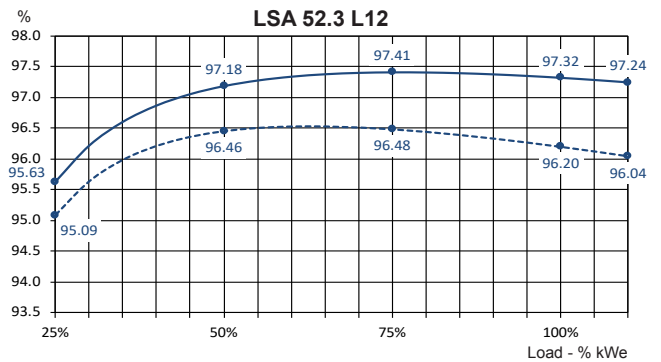
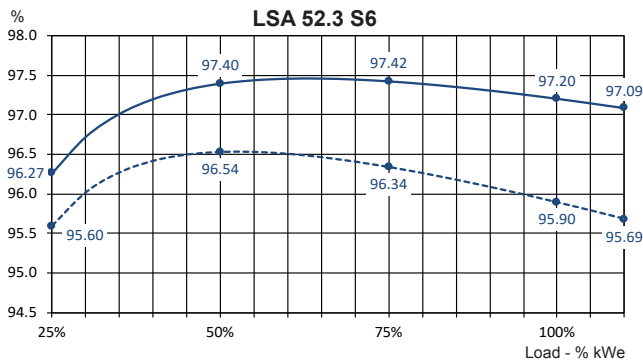
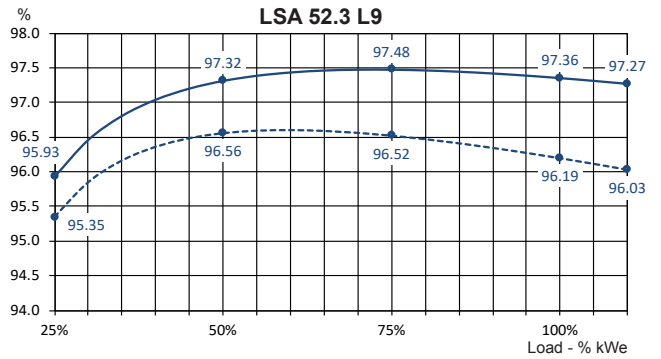
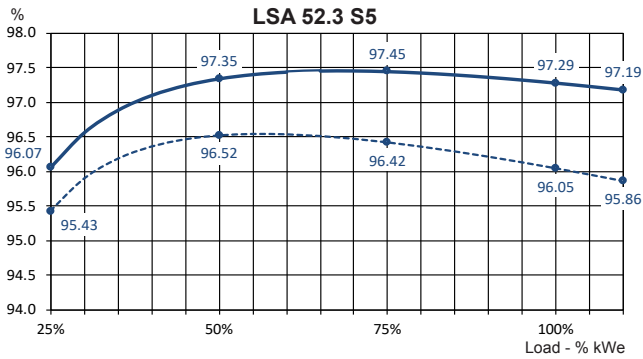

Reactances (%). Time constants (ms) - Class H / 400 V

| | S5 | S6 | S7 | L9 | L12 | UL16 |
|--|------|------|------|------|------|------|
| Kcc Short-circuit ratio | 0.35 | 0.32 | 0.35 | 0.39 | 0.42 | 0.51 |
| Xd Direct-axis synchronous reactance unsaturated | 367 | 380 | 376 | 344 | 313 | 267 |
| Xq Quadrature-axis synchronous reactance unsaturated | 187 | 194 | 192 | 175 | 160 | 136 |
| T'do No-load transient time constant | 2760 | 2760 | 2870 | 2990 | 2760 | 2920 |
| X'd Direct-axis transient reactance saturated | 28.7 | 30.9 | 28.9 | 26.1 | 23.6 | 20.3 |
| T'd Short-circuit transient time constant | 254 | 264 | 260 | 267 | 245 | 261 |
| X''d Direct-axis subtransient reactance saturated | 15 | 16.4 | 14.8 | 13.2 | 12.1 | 10.5 |
| T''d Subtransient time constant | 23 | 23 | 22 | 22 | 13 | 14 |
| X''q Quadrature-axis subtransient reactance saturated | 15.6 | 16.9 | 15.4 | 13.7 | 12.5 | 10.8 |
| X0 Zero sequence reactance | 2.3 | 2.5 | 2.6 | 2.5 | 2.7 | 2.6 |
| X2 Negative sequence reactance saturated | 15.3 | 16.7 | 15.1 | 13.4 | 12.3 | 10.6 |
| Ta Armature time constant | 28 | 28 | 28 | 28 | 29 | 30 |

Other class H/400 V data

| | | | | | | |
|--|-----|-----|------|------|-----|-----|
| io (A) No-load excitation current | 1.2 | 1.2 | 1.2 | 1.2 | 1.3 | 1.4 |
| ic (A) On-load excitation current | 4.2 | 4.5 | 4.4 | 4.2 | 4 | 3.7 |
| uc (V) On-load excitation voltage | 45 | 47 | 47 | 44 | 42 | 38 |
| kW No-load losses | 15 | 15 | 17 | 20 | 24 | 26 |
| kW Heat dissipation | 68 | 76 | 79.5 | 79.2 | 81 | 100 |

Transient voltage variation at load inrush: 400V - 50 Hz

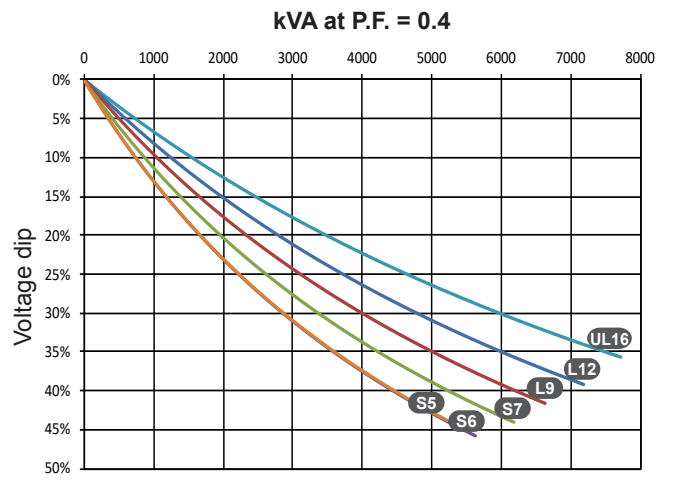
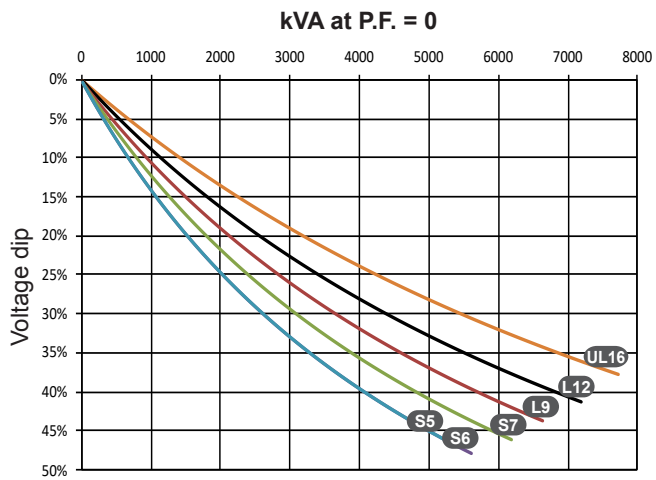
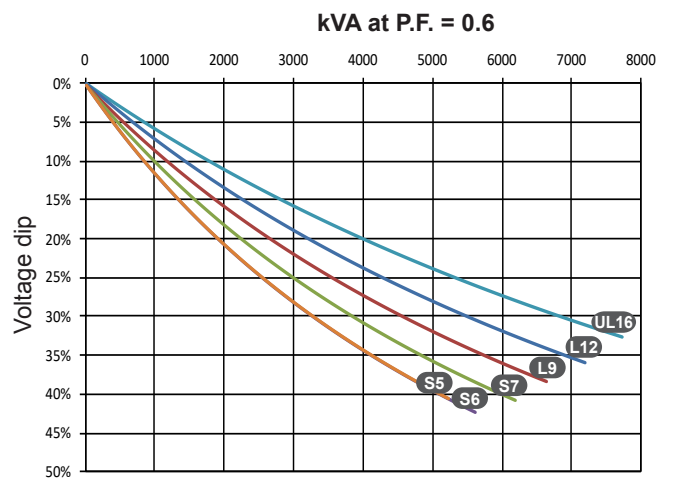
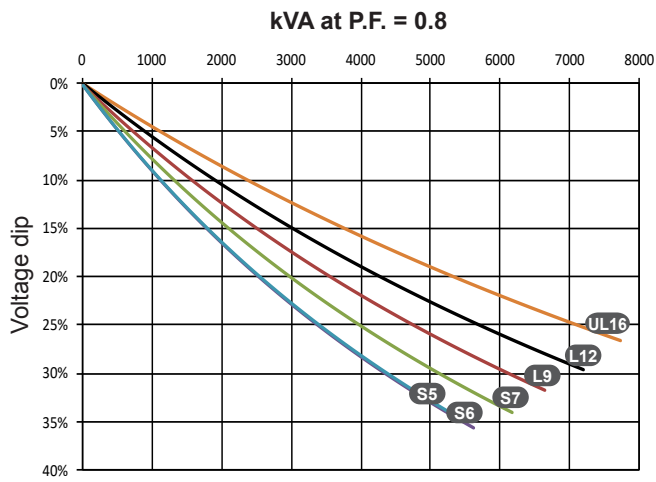

Transient voltage variation at load rejection: 400V - 50 Hz

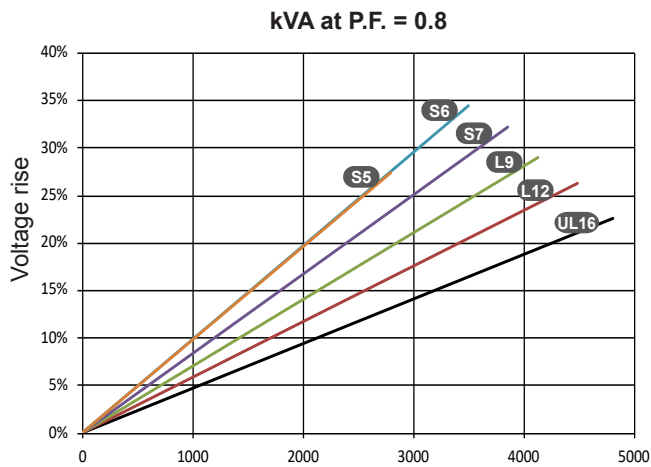

Efficiencies 480V - 60 Hz (— P.F.: 1) (----- P.F.: 0.8)

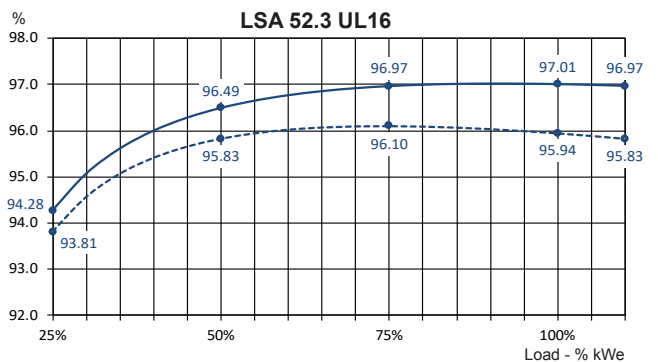
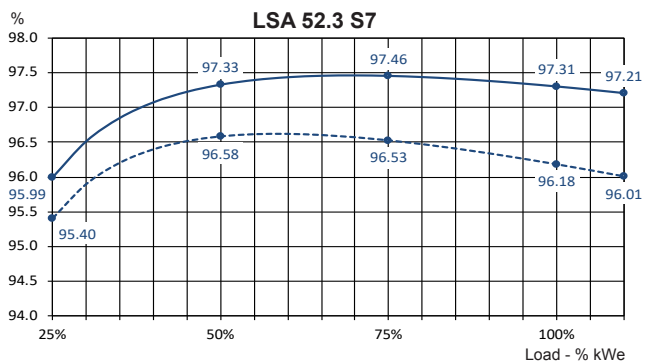
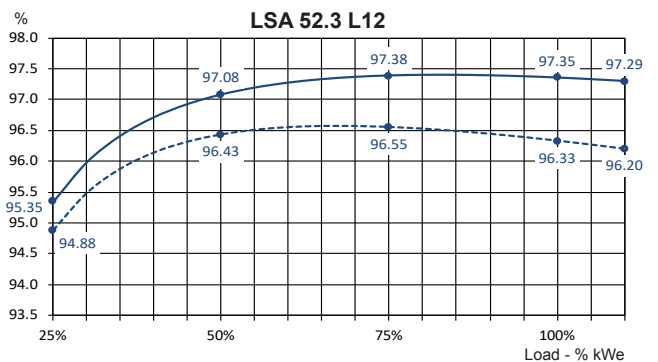
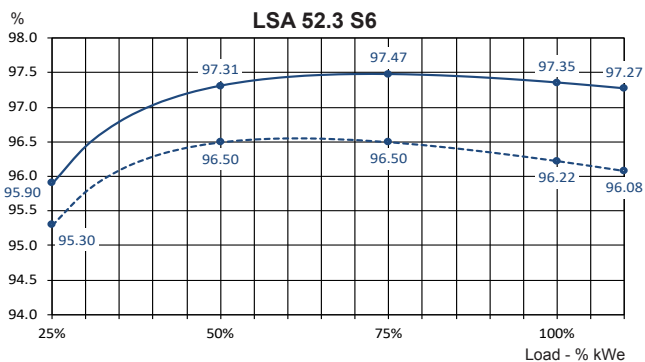
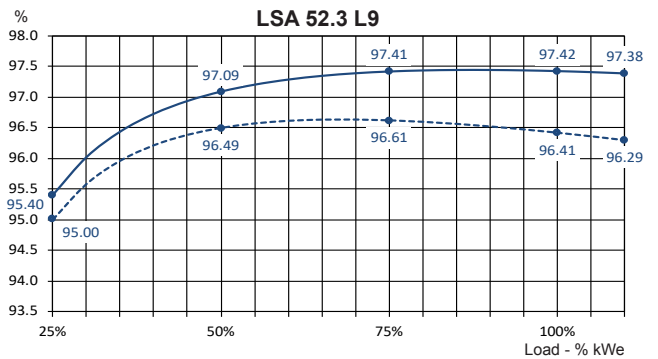
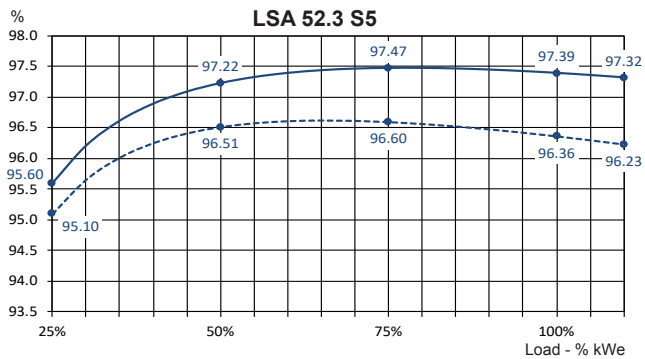

Reactances (%). Time constants (ms) - Class H / 480 V

| | S5 | S6 | S7 | L9 | L12 | UL16 |
|--|------|------|------|------|------|------|
| Kcc Short-circuit ratio | 0.35 | 0.32 | 0.35 | 0.39 | 0.40 | 0.49 |
| Xd Direct-axis synchronous reactance unsaturated | 367 | 380 | 376 | 344 | 331 | 275 |
| Xq Quadrature-axis synchronous reactance unsaturated | 187 | 194 | 192 | 175 | 169 | 140 |
| T'do No-load transient time constant | 2760 | 2760 | 2870 | 2990 | 2760 | 2920 |
| X'd Direct-axis transient reactance saturated | 28.7 | 30.9 | 28.9 | 26.1 | 25 | 20.9 |
| T'd Short-circuit transient time constant | 254 | 265 | 260 | 267 | 245 | 261 |
| X''d Direct-axis subtransient reactance saturated | 15 | 16.4 | 14.8 | 13.2 | 12.8 | 10.8 |
| T''d Subtransient time constant | 23 | 23 | 22 | 22 | 13 | 14 |
| X''q Quadrature-axis subtransient reactance saturated | 15.6 | 16.9 | 15.4 | 13.7 | 13.2 | 11.1 |
| X0 Zero sequence reactance | 2.3 | 2.6 | 2.6 | 2.5 | 2.9 | 2.7 |
| X2 Negative sequence reactance saturated | 15.3 | 16.7 | 15.1 | 13.4 | 13 | 11 |
| Ta Armature time constant | 28 | 28 | 28 | 28 | 29 | 30 |

Other class H/480 V data

| | | | | | | |
|--|-----|-----|-----|-----|-----|-----|
| io (A) No-load excitation current | 1.1 | 1.1 | 1.2 | 1.2 | 1.2 | 1.3 |
| ic (A) On-load excitation current | 4 | 4.3 | 4.3 | 4 | 4 | 3.6 |
| uc (V) On-load excitation voltage | 43 | 46 | 45 | 43 | 42 | 36 |
| kW No-load losses | 21 | 21 | 24 | 28 | 33 | 36 |
| kW Heat dissipation | 73 | 82 | 86 | 87 | 96 | 120 |

Transient voltage variation at load inrush: 480V - 60 Hz

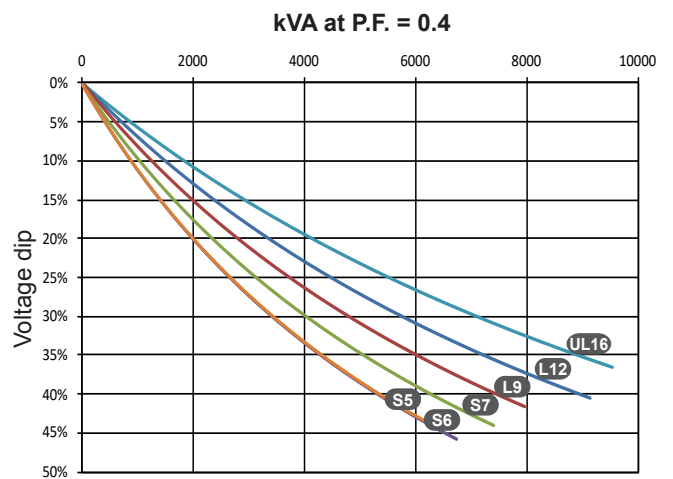
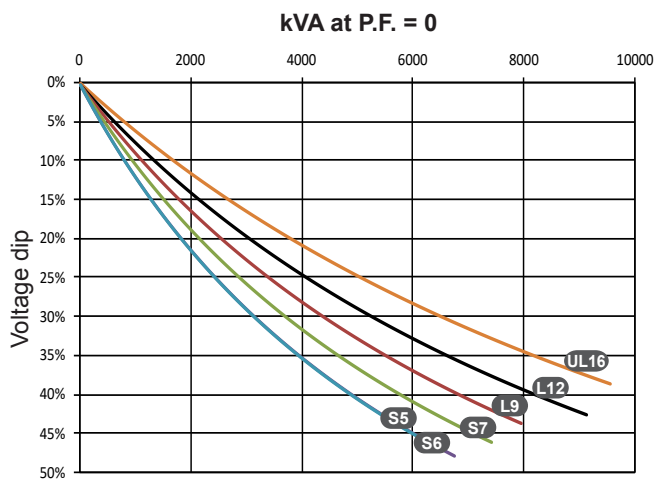
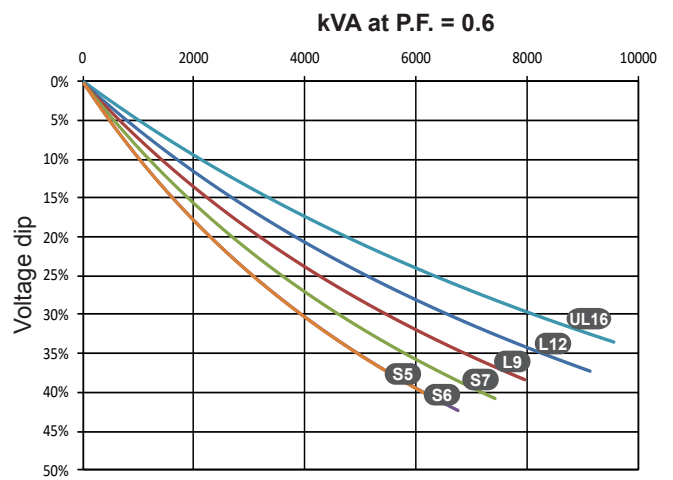
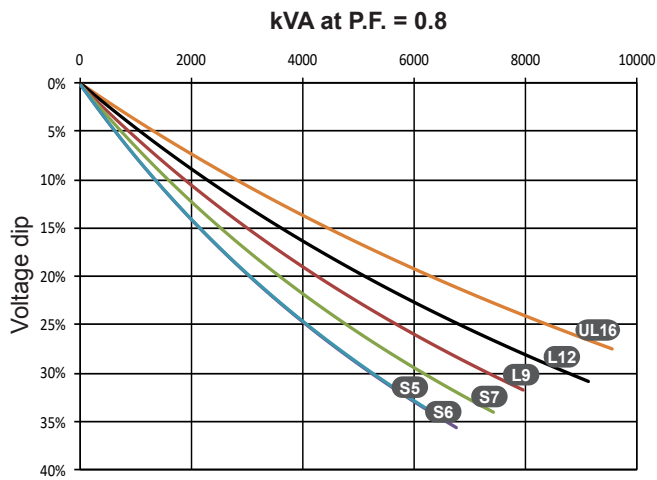

Transient voltage variation at load rejection: 480V - 60 Hz

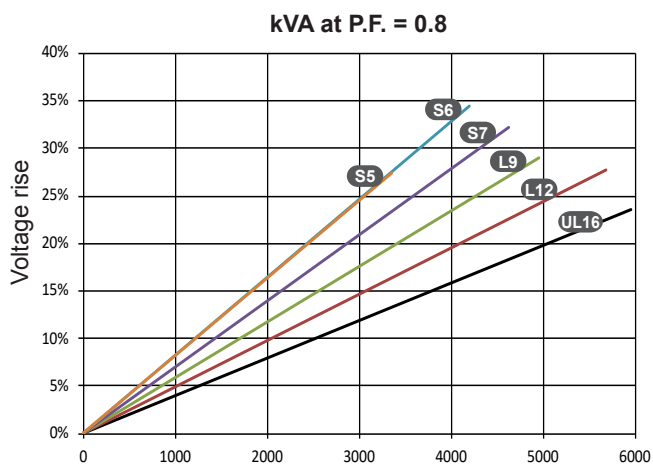

Short-circuit curves at rated speed (star connection Y)

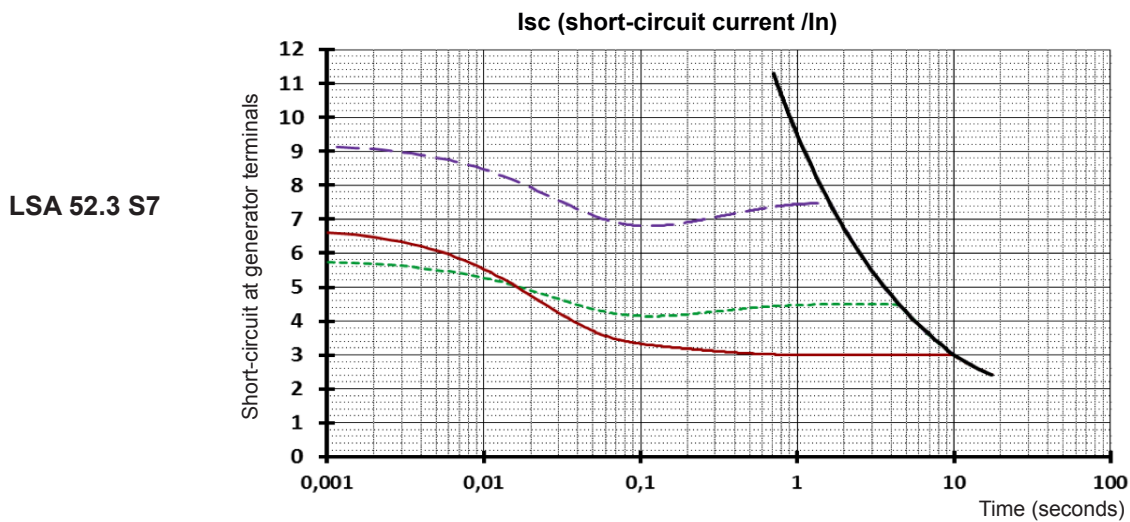
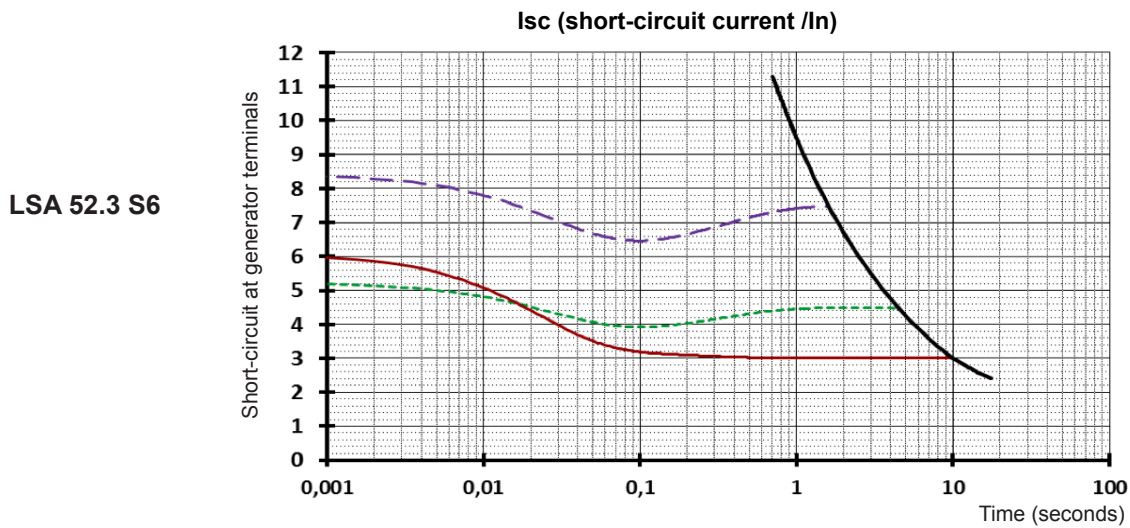
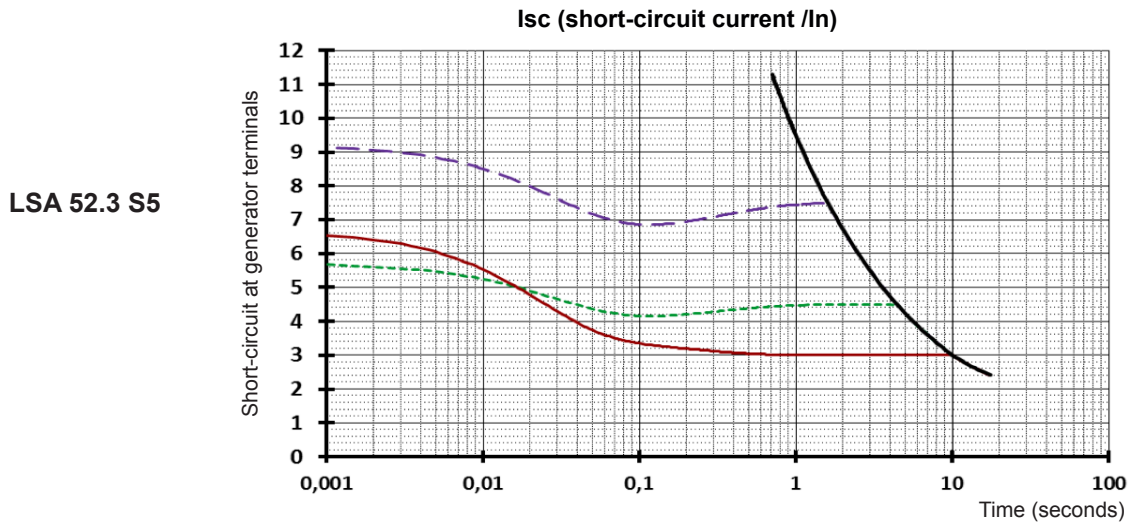

- Symmetrical phase to neutral short-circuit
- - - Symmetrical two-phase short-circuit
- Symmetrical three-phase short-circuit
- Thermal limit curve

Short-circuit curves at rated speed (star connection Y)

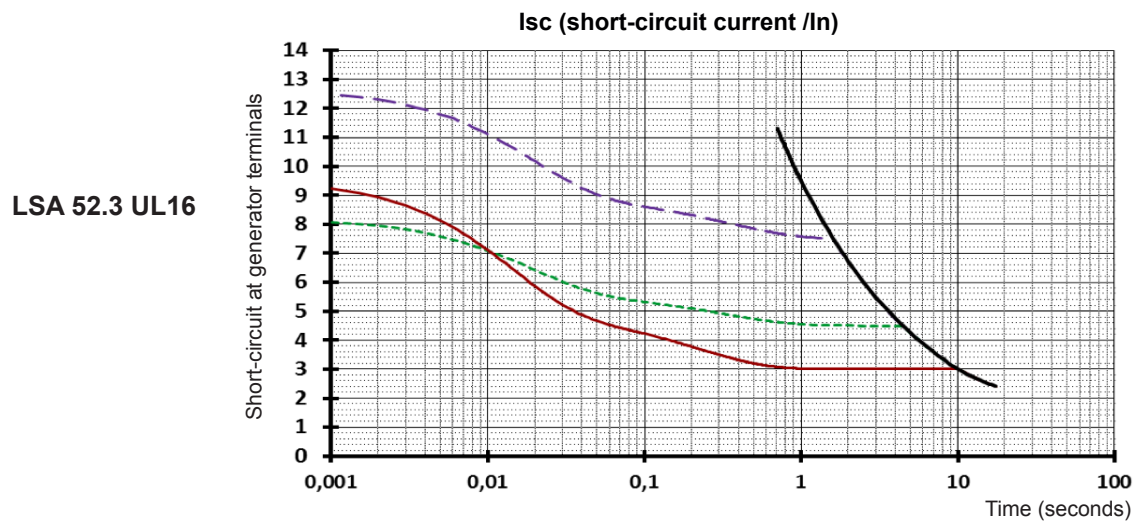
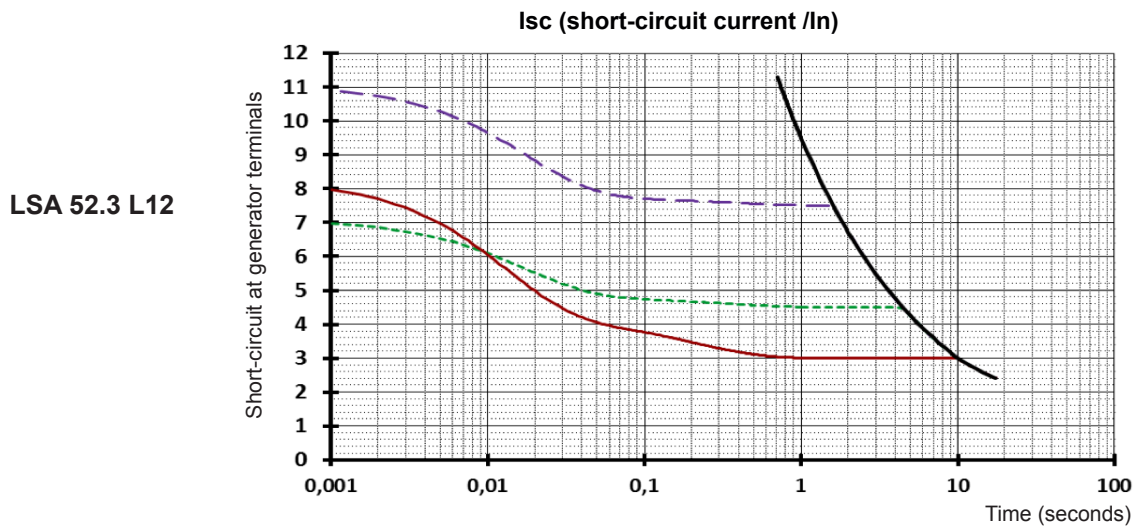
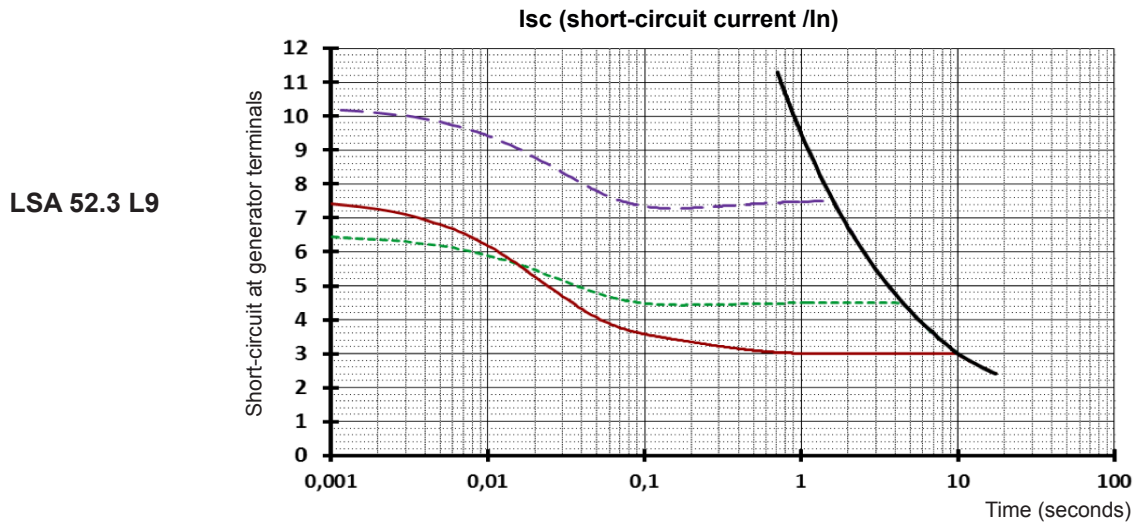

- Symmetrical phase to neutral short-circuit
- - Symmetrical two-phase short-circuit
- Symmetrical three-phase short-circuit
- Thermal limit curve

Single bearing dimensions

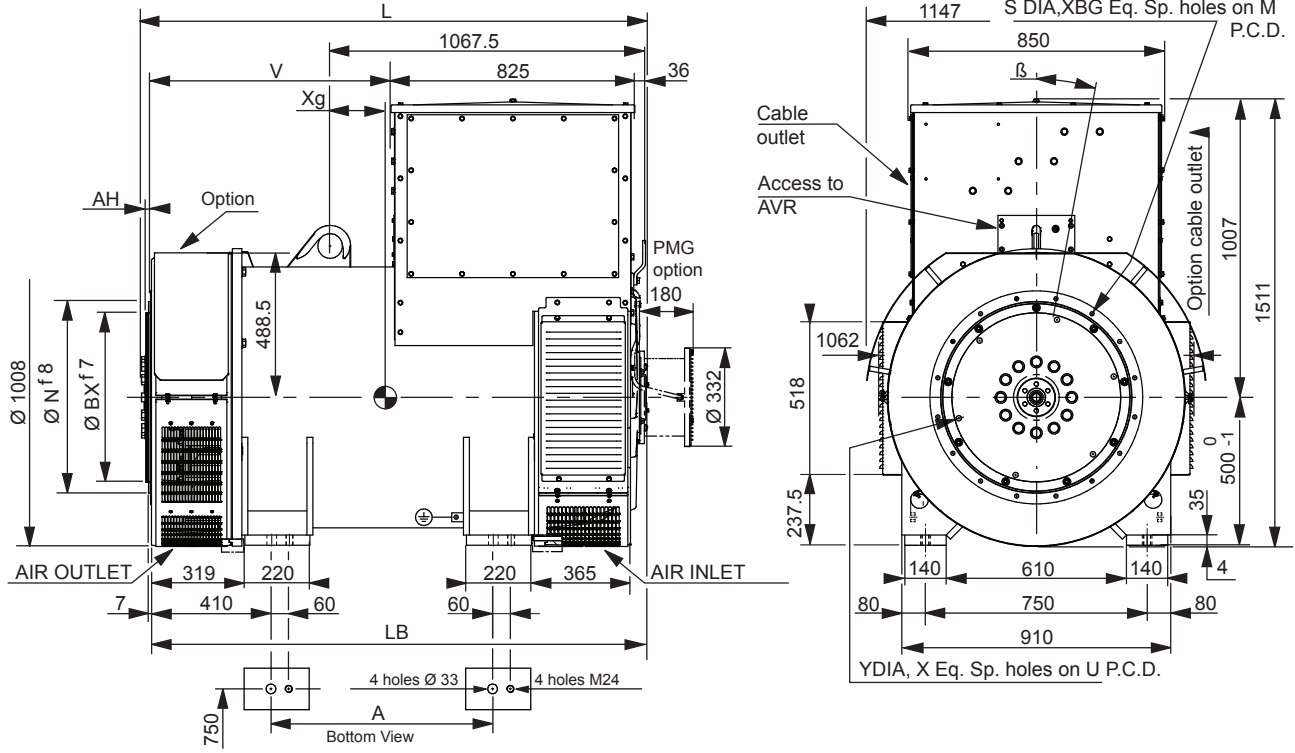

| Dimensions (mm) and weight | | | | | | |
|----------------------------|---------------------|------|-----|------|-----|---------------|
| Type | L without PMG maxi* | LB | A | V | Xg | Weight** (kg) |
| LSA 52.3 S5 | 1713 | 1683 | 750 | 814 | 187 | 3705 |
| LSA 52.3 S6 | 1713 | 1683 | 750 | 814 | 187 | 3705 |
| LSA 52.3 S7 | 1713 | 1683 | 750 | 814 | 207 | 3950 |
| LSA 52.3 L9 | 1913 | 1883 | 950 | 1014 | 78 | 4433 |
| LSA 52.3 L12 | 1913 | 1883 | 950 | 1014 | 112 | 4924 |

| Coupling | | |
|----------------------|---|----|
| Flange S.A.E. | 0 | 00 |
| Flex plate S.A.E. 21 | | X |
| Flex plate S.A.E. 18 | X | X |

LSA 52.3 UL16 (consult us)
 * L maxi = LB + AH maxi + 14 ** Values for S.A.E. 00/21

| Flange (mm) | | | | | |
|-------------|-------|-------|-----|----|---------|
| S.A.E. | N | M | XBG | S | β° |
| 0 | 647.7 | 679.5 | 16 | 14 | 11°15' |
| 00 | 787.4 | 850.9 | 16 | 14 | 11° 15' |

| Flex plate (mm) | | | | | |
|-----------------|-------|-------|----|----|------|
| S.A.E. | BX | U | X | Y | AH |
| 21 | 673.1 | 641.3 | 12 | 18 | 0 |
| 18 | 571.5 | 542.9 | 6 | 18 | 15.8 |

Torsional analysis data

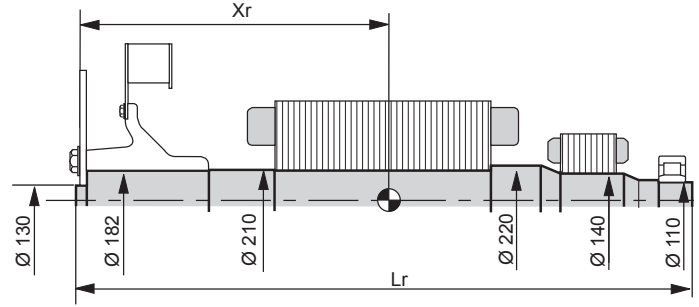
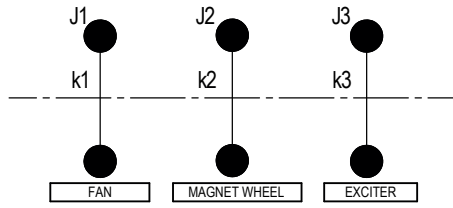

| Centre of gravity: Xr (mm), Rotor length: Lr (mm), Weight: M (kg), Moment of inertia: J (kgm ²) : (4J = MD ²) | | | | | | | | | | Torsional rigidity | | | | | |
|---|-----------|------|------|------|-----------|------|------|------|-----------|--------------------|-----------|----------------------|------|-----|--|
| Flex plate | S.A.E. 18 | | | | S.A.E. 21 | | | | [Nm/rad] | | | (kg.m ²) | | | |
| | Xr | Lr | M | J | Xr | Lr | M | J | k1 | k2 | k3 | J1 | J2 | J3 | |
| LSA 52.3 S5 | 720.4 | 1689 | 1420 | 43.4 | 702.8 | 1689 | 1424 | 44.3 | 5.00 10E7 | 2.50 10E7 | 1.54 10E7 | 10.3 | 32.4 | 1.5 | |
| LSA 52.3 S6 | 720.4 | 1689 | 1420 | 43.4 | 702.8 | 1689 | 1424 | 44.3 | 5.00 10E7 | 2.50 10E7 | 1.54 10E7 | 10.3 | 32.4 | 1.5 | |
| LSA 52.3 S7 | 741.5 | 1689 | 1453 | 45 | 723.9 | 1689 | 1457 | 45.9 | 5.00 10E7 | 2.41 10E7 | 1.59 10E7 | 10.3 | 34.1 | 1.5 | |
| LSA 52.3 L9 | 811.3 | 1889 | 1635 | 50 | 793.7 | 1889 | 1639 | 50.9 | 5.00 10E7 | 2.29 10E7 | 1.42 10E7 | 10.3 | 39 | 1.6 | |
| LSA 52.3 L12 | 858.4 | 1889 | 1808 | 56.5 | 840.9 | 1889 | 1812 | 57.4 | 5.00 10E7 | 2.14 10E7 | 1.52 10E7 | 10.3 | 45.6 | 1.4 | |

LSA 52.3 UL16 (consult us)

NOTE : Dimensions are for information only and may be subject to modifications. Contractual 2D drawings can be downloaded from the Leroy-Somer site, 3D drawing files are available upon request. The torsional analysis of the transmission is imperative. All values are available upon request.

Two bearing dimensions

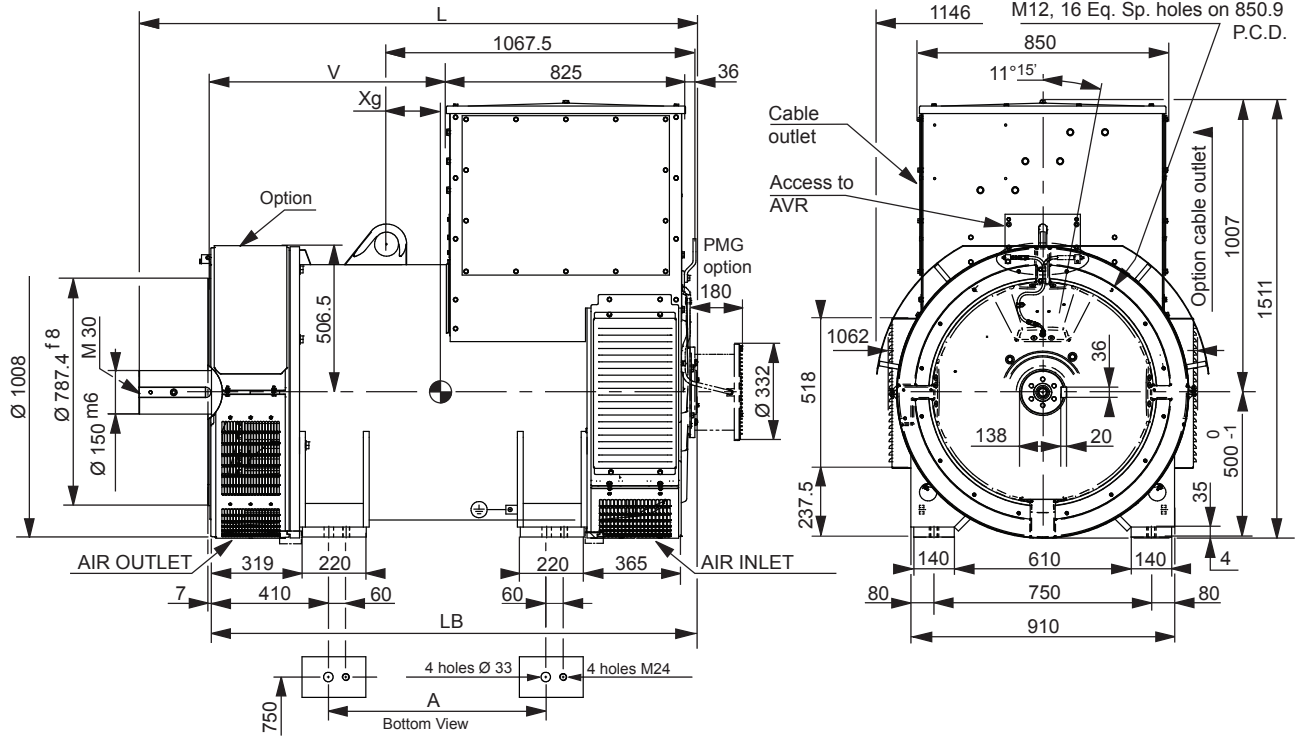

Dimensions (mm) and weight

| Type | L without PMG | LB | A | V | Xg | Weight (kg) |
|--------------|---------------|------|-----|------|-----|-------------|
| LSA 52.3 S5 | 1933 | 1683 | 750 | 814 | 192 | 3748 |
| LSA 52.3 S6 | 1933 | 1683 | 750 | 814 | 192 | 3748 |
| LSA 52.3 S7 | 1933 | 1683 | 750 | 814 | 212 | 3991 |
| LSA 52.3 L9 | 2133 | 1883 | 950 | 1014 | 83 | 4476 |
| LSA 52.3 L12 | 2133 | 1883 | 950 | 1014 | 117 | 4967 |

LSA 52.3 UL16 (consult us)

Torsional analysis data

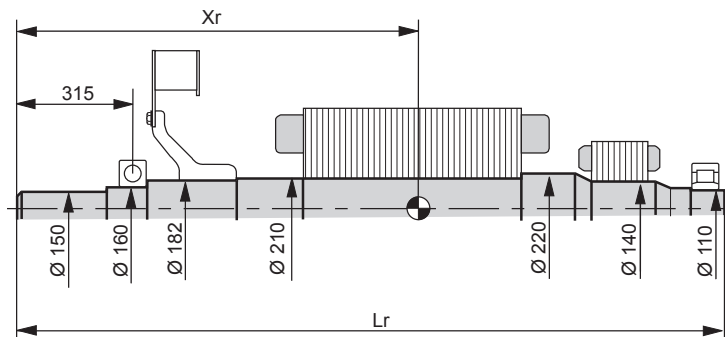
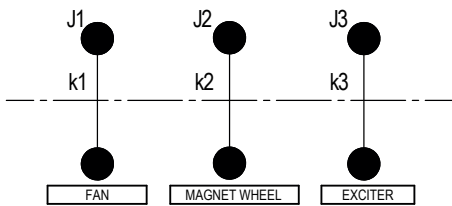

Centre of gravity: Xr (mm), Rotor length: Lr (mm), Weight: M (kg), Moment of inertia: J (kgm²) : (4J = MD²)

| Type | Xr | Lr | M | J |
|--------------|--------|------|------|------|
| LSA 52.3 S5 | 973.4 | 1912 | 1363 | 41.7 |
| LSA 52.3 S6 | 973.4 | 1912 | 1363 | 41.7 |
| LSA 52.3 S7 | 994.5 | 1912 | 1396 | 43.3 |
| LSA 52.3 L9 | 1064.3 | 2112 | 1578 | 48.3 |
| LSA 52.3 L12 | 1110.6 | 2112 | 1752 | 54.8 |

Torsional rigidity

| [Nm/rad] | | | (kg.m ²) | | |
|-----------|-----------|-----------|----------------------|------|-----|
| k1 | k2 | k3 | J1 | J2 | J3 |
| 1.82 10E7 | 3.05 10E7 | 1.54 10E7 | 7.7 | 32.4 | 1.5 |
| 1.82 10E7 | 3.05 10E7 | 1.54 10E7 | 7.7 | 32.4 | 1.5 |
| 1.82 10E7 | 2.91 10E7 | 1.59 10E7 | 7.7 | 34.1 | 1.5 |
| 1.82 10E7 | 2.74 10E7 | 1.42 10E7 | 7.7 | 39 | 1.6 |
| 1.82 10E7 | 2.53 10E7 | 1.52 10E7 | 7.7 | 45.6 | 1.4 |

LSA 52.3 UL16 (consult us)

NOTE : Dimensions are for information only and may be subject to modifications. Contractual 2D drawings can be downloaded from the Leroy-Somer site, 3D drawing files are available upon request. The torsional analysis of the transmission is imperative. All values are available upon request.

LEROY-SOMER[™]

www.leroy-somer.com/epg

[Linkedin.com/company/leroy-somer](https://www.linkedin.com/company/leroy-somer)
[Twitter.com/Leroy_Somer_en](https://twitter.com/Leroy_Somer_en)
[Facebook.com/LeroySomer.Nidec.en](https://www.facebook.com/LeroySomer.Nidec.en)
[YouTube.com/LeroySomerOfficiel](https://www.youtube.com/LeroySomerOfficiel)



Nidec
All for dreams

© Nidec 2020. The information contained in this brochure is for guidance only and does not form part of any contract. The accuracy cannot be guaranteed as Nidec have an ongoing process of development and reserve the right to change the specification of their products without notice.

Moteurs Leroy-Somer SAS. Siège : Bd Marcellin Leroy, CS 10015, 16915 Angoulême Cedex 9, France.
Capital social : 65 800 512 €, RCS Angoulême 338 567 258.